

4 Gallon 80 Mil Bucket
Smooth Surface Finish

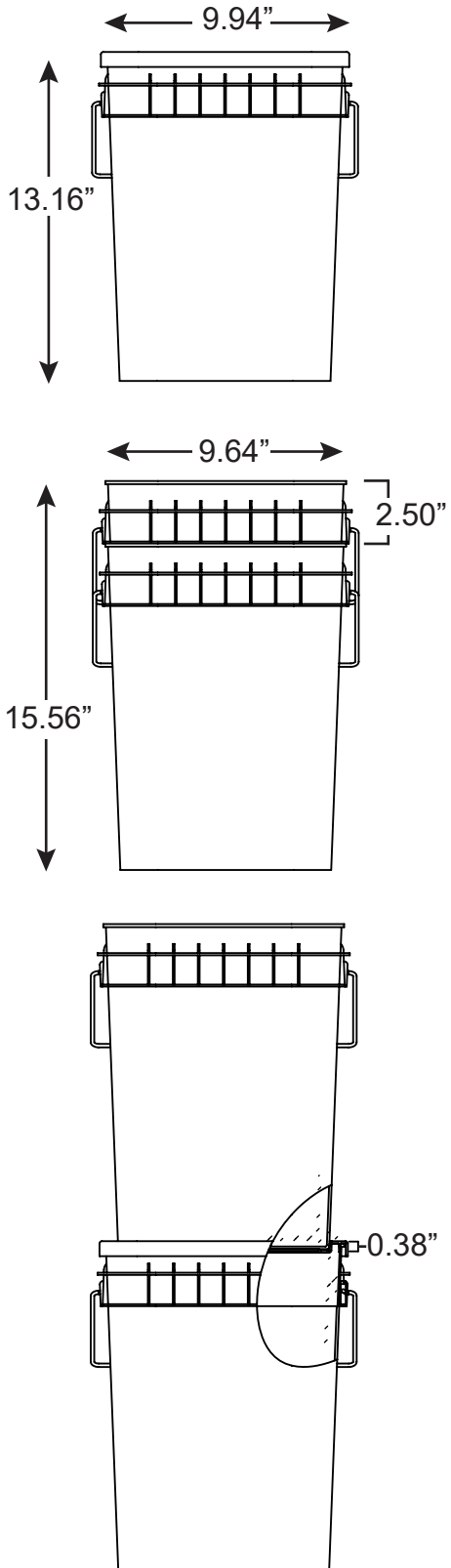

Components

- Material: HDPE High Density Polyethylene
- Standard color: White (See Color List On Page 2)
- Metal handle with plastic hand grip
- No gasket, no safety tear tab, press-on lid

Wall Thickness	inch	cm
Bucket	.073	.185
Snap On Lid (4LID)	.063	.159

Standard Weight (+/- 2%)	lb.	g
Bucket (with handle)	1.54	700
Snap On Lid	0.28	129

Thermal Resistance (tested with water)

Filling from -31°F (-35°C) to 170°F (77°C)
Warehousing from -30°F (-34°C) to 92°F (33°C)

Capacities

Volume	gallons	liters
Nominal	4	15.14
Maximum to Overflow	4.15	16.56
Maximum with Lid	4.05	15.41

Product Density(g/cm ³)	Max Weight Filled with Lid	
	lb.	kg
0.5	16.99	7.71
0.6	20.38	9.25
0.7	23.78	10.79
0.8	27.18	12.33
0.9	30.58	13.87
1.0	33.97	15.41
1.1	37.37	16.95
1.2	40.77	18.49

Specifications given are guidelines only. Manufacturer does not guarantee exact measurements of specifications. Customer should verify specific product to be packaged.

Pallet Utilization

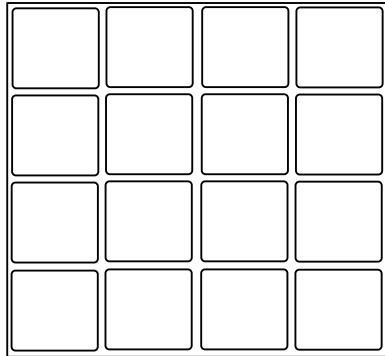

40" x 48" (122 cm x 102 cm)

IMPORTANT

Never let buckets overlap edge of pallet.

Recommended Stacking Height

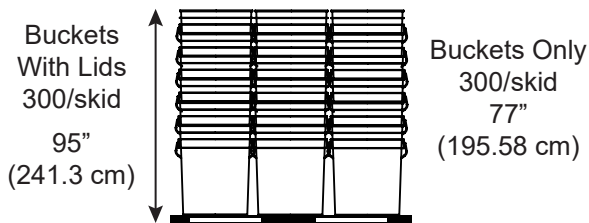

Filled Buckets - 48

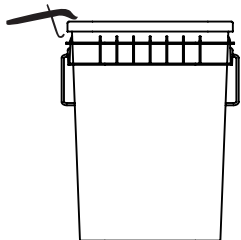
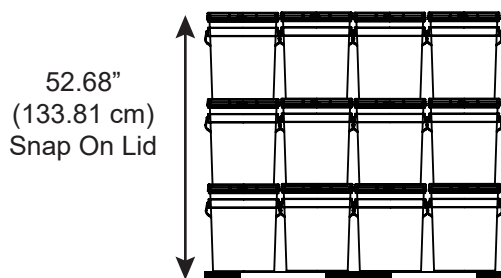

Open With
Lid Lifter

Close With
Dead Blow Hammer

Depress lid center to
force out excess air

Or Use a Closing Tool

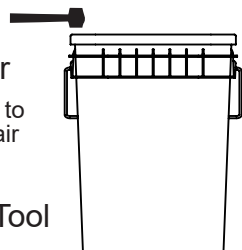

Printing

Very simple artwork. Hot stamp printing. 3" x 6".

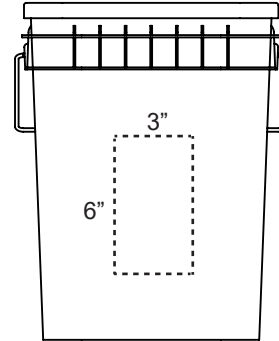

APPROVALS

Affordable Buckets, L.L.C. disclaims any liability for the user of the information and data contained herein. We reserve the right to alter or modify any product and/or specification, at any time.

Shipping Data

Buckets With Lids

Quantity	Dimensions*	# Skids	Weight (Lbs)
300	40 x 48 x 95	1	636
600	40 x 48 x 95	2	1272
900	40 x 48 x 95	3	1908
1200	40 x 48 x 95	4	2544
1500	40 x 48 x 95	5	3180
1800	40 x 48 x 95	6	3816

*includes wooden pallet

Buckets Only

Quantity	Dimensions*	# Skids	Weight (Lbs)
300	40 x 48 x 77	1	510
600	40 x 48 x 77	2	1020
900	40 x 48 x 77	3	1530
1200	40 x 48 x 77	4	2040
1500	40 x 48 x 77	5	2550
1800	40 x 48 x 77	6	3060

*includes wooden pallet

Specifications given are guidelines only. Manufacturer does not guarantee exact measurements of specifications. Customer should verify specific product to be packaged.

Available Colors 4GB(COLOR)

- | | | |
|-------------|--------------------|--------------|
| Black (BLK) | Green (GRN) | Purple (PPL) |
| Blem (BLEM) | Lime Green (LIGRN) | Red (RED) |
| Blue (BLU) | Natural (NAT) | White (WHT) |
| Gray (GRY) | Orange (ORG) | Yellow (YEL) |